

ALOFT HOTELS - GENERATION 4.0

Marriot Global Design Standards

National Program Guide

May 2023



INAX

PART OF LIXIL

*American
Standard*

DXXV



INAX

PART OF **LIXIL**



ENERGY CONSERVATION ENERGY CREATION

Mega-solar power plant at the **LIXIL** Chita Plant in Japan

LIXIL is the most **comprehensive global company in the housing and building industry**. We provide **human-centric innovations** that **enhance** people's living space. From **sanitary fixtures** and **fittings** to a **full line-up** of materials for **residential and commercial**. We bring to market **beautiful design, reliable quality, innovation, environmentally-friendly products** with a **responsible approach to business and the planet**.

LIXIL Link to
Good Living



STANDARD GUEST ROOMS - SHOWER ONLY

	SKU No. 33170003	P-Number Not on Spec PL-200-LI	Color/Finish Starlight chrome	
	List	Net	Quantity 1	Total
	GROHE Plus Single Hole Single Handle S-Size Bathroom Faucet Flow Rate 4.5 LPM (1.2 GPM) maximum flowrate Faucet Flow Control GROHE AquaGuide adjustable flow control Operation Manual Number of Handles Single handle Faucet Type Lavatory faucet Color / Finish StarLight chrome EPA WaterSense EPA WaterSense® compliant			
 	SKU No. 0496221.020	P-Number Not on Spec PL-100-LI	Color/Finish White	
	List	Net	Quantity 1	Total
	American Standard Ovalyn Undercounter Sink Collection OVALYN Basin Type Lavatory Material Vitreous china Color / Finish White Mounting Counter mounted ADA ANSI A117.1 compliant			

ALOFT HOTELS - GENERATION 4.0
Marriot Global Design Standards
National Program Guide
May 2023



STANDARD GUEST ROOMS - SHOWER ONLY

 	SKU No.	P-Number	Color/Finish
	0630000.020	Not on Spec PL-100-LI	White
	List	Net	Quantity
		1	
American Standard Orbit™ Undercounter Sink Vitreous China			
Barrier Free			
Collection	ORBIT		
Basin Type	Lavatory		
Material	Vitreous china		
Color / Finish	White		
Mounting	Counter mounted		
ADA	ANSI A117.1 compliant		

ALOFT HOTELS - GENERATION 4.0
Marriot Global Design Standards
National Program Guide
May 2023



STANDARD GUEST ROOMS - SHOWER ONLY

	SKU No.	P-Number	Color/Finish
	26043001	Not on Spec PL-400-LI	Starlight chrome
	List	Net	Quantity
		1	
GROHE New Tempesta Cosmopolitan 100 Shower Head 4 Sprays			
ASME Compliance	ASME A112.18.1		
CALGreen Compliance	CALGreen compliant		
CEC	California Energy Commission (CEC) compliant		
Cleaning	SpeedClean® anti-lime system		
Connection	1/2" connection thread		
CSA Compliance	CSA B125.1		
EPA Compliance	Energy Policy Act of 1992		
EPA Watersense	EPA WaterSense®		
Face Diameter	4" face		
Color / Finish	StarLight chrome		
Flow Rate	EcoJoy 2.0 GPM (7.6 l/min) flow limiter		
Function	4 sprays: GROHE Rain O², Rain, Massage and Jet		
Installation	Installed on shower arm		
Manufacturer	GROHE		
Minimum Pressure	103 kPa (15 PSI) minimum recommended pressure		
Shower Head Type	Residential		
Spray	Multispray		
Spray Pattern	DreamSpray perfect spray pattern		
US Federal	US Federal and State material regulations compliant		

ALOFT HOTELS - GENERATION 4.0
Marriot Global Design Standards
National Program Guide
May 2023



STANDARD GUEST ROOMS - SHOWER ONLY

	SKU No. 27414000	P-Number Not on Spec PL-401-LI	Color/Finish Starlight chrome	
	List	Net	Quantity 1	Total
	GROHE 5 5/8" Tubular Shower Arm Connection 1/2" Connection thread Color / Finish Starlight chrome Manufacturer GROHE Projection 5-5/8" projection			
	SKU No. 14468000	P-Number Not on Spec PL-801	Color/Finish	
	List	Net	Quantity 1	Total
	GROHE Concetto Pressure Balance Trim With Cartridge Kit Type Valve trim Suggested Rough Valve For use with GrohSafe 3.0 rough-in valves (35 110), (35 111), (35 112), (35 113), (35 114), (35 115), (35 116)			
	SKU No. 35110000	P-Number Not on Spec PL-800-LI	Color/Finish	
	List	Net	Quantity 1	Total
	GROHE Pressure Balance Valve Rough With Universal With Service Stops Cartridge Cartridge ships with the trim			



ALOFT HOTELS - GENERATION 4.0
Marriot Global Design Standards
National Program Guide
May 2023





STANDARD GUEST ROOMS - SHOWER ONLY

 	SKU No. 211AA104.020	P-Number Not on Spec PL-300	Color/Finish White	
	List	Net	Quantity 1	Total
	American Standard Champion® Pro Right Height® Elongated Toilet Collection CHAMPION® PRO™ Fixture Type Toilet Toilet Type Tank type Mounting And Waste Floor mounted with floor outlet Toilet Water Consumption High Efficiency HET 4.8 LPF (1.28 GPF) Material Vitreous china Antimicrobial EverClean® antimicrobial surface Color / Finish White Bowl Shape Elongated bowl			
	SKU No. 5257A65MT.020	P-Number Not on Spec PL-302	Color/Finish White	
	List	Net	Quantity 1	Total
	American Standard Toilet Seat For Elongated Bowl Closed Front With Seat Cover Everclean Antimicrobial Surface Toilet Bowl For elongated bowl Application For residential applications Grade Light duty Seat Type Closed front Cover With seat cover Color / Finish White Antimicrobial EverClean® antimicrobial surface			

STANDARD GUEST ROOMS - TUB/SHOWER COMBO

	SKU No. 33170003	P-Number Not on Spec PL-200-LI	Color/Finish StarLight chrome
	List	Net	Quantity 1
	GROHE Plus Single Hole Single Handle S-Size Bathroom Faucet Flow Rate 4.5 LPM (1.2 GPM) maximum flowrate Faucet Flow Control GROHE AquaGuide adjustable flow control Operation Manual Number of Handles Single handle Faucet Type Lavatory faucet Color / Finish StarLight chrome EPA WaterSense EPA WaterSense® compliant		
 	SKU No. 0496221.020	P-Number Not on Spec PL-100-LI	Color/Finish White
	List	Net	Quantity 1
	American Standard Ovalyn Undercounter Sink Collection OVALYN Basin Type Lavatory Material Vitreous china Color / Finish White Mounting Counter mounted ADA ANSI A117.1 compliant		

STANDARD GUEST ROOMS - TUB/SHOWER COMBO

 	SKU No.	P-Number	Color/Finish
	0630000.020	Not on Spec PL-100-LI	White
	List	Net	Quantity
		1	
American Standard Orbit™ Undercounter Sink Vitreous China			
Barrier Free			
Collection	ORBIT		
Basin Type	Lavatory		
Material	Vitreous china		
Color / Finish	White		
Mounting	Counter mounted		
ADA	ANSI A117.1 compliant		



ALOFT HOTELS - GENERATION 4.0
Marriot Global Design Standards
National Program Guide
May 2023





STANDARD GUEST ROOMS - TUB/SHOWER COMBO

	SKU No.	P-Number	Color/Finish
	26043001	Not on Spec PL-400-LI	Starlight chrome
	List	Net	Quantity
		1	
GROHE New Tempesta Cosmopolitan 100 Shower Head 4 Sprays			
ASME Compliance	ASME A112.18.1		
CALGreen Compliance	CALGreen compliant		
CEC	California Energy Commission (CEC) compliant		
Cleaning	SpeedClean® anti-lime system		
Connection	1/2" connection thread		
CSA Compliance	CSA B125.1		
EPA Compliance	Energy Policy Act of 1992		
EPA Watersense	EPA WaterSense®		
Face Diameter	4" face		
Color / Finish	StarLight chrome		
Flow Rate	EcoJoy 2.0 GPM (7.6 l/min) flow limiter		
Function	4 sprays: GROHE Rain O², Rain, Massage and Jet		
Installation	Installed on shower arm		
Manufacturer	GROHE		
Minimum Pressure	103 kPa (15 PSI) minimum recommended pressure		
Shower Head Type	Residential		
Spray	Multispray		
Spray Pattern	DreamSpray perfect spray pattern		
US Federal	US Federal and State material regulations compliant		



STANDARD GUEST ROOMS - TUB/SHOWER COMBO

	SKU No. 27414000	P-Number Not on Spec PL-401	Color/Finish Starlight chrome
	List	Net	Quantity 1
	GROHE 5 5/8" Tubular Shower Arm Connection 1/2" Connection thread Color / Finish Starlight chrome Manufacturer GROHE Projection 5-5/8" projection		
	SKU No. 14468000	P-Number Not on Spec PL-801	Color/Finish Starlight chrome
	List	Net	Quantity 1
	GROHE Concetto Pressure Balance Trim With Cartridge Kit Type Valve trim Suggested Rough Valve For use with GrohSafe 3.0 rough-in valves (35 110), (35 111), (35 112), (35 113), (35 114), (35 115), (35 116)		
	SKU No. 35110000	P-Number Not on Spec PL-800-LI	Color/Finish
	List	Net	Quantity 1
	GROHE Pressure Balance Valve Rough With Universal With Service Stops Cartridge Cartridge ships with the trim		

STANDARD GUEST ROOMS - TUB/SHOWER COMBO

	SKU No. 13366000	P-Number Not on Spec PL-600-LI	Color/Finish Starlight chrome	
	List	Net	Quantity 1	Total
	GROHE Concetto Diverter Tub Spout Diverter Diverter Tub Spout Color / Finish StarLight chrome Installation SlipFit installation Manufacturer GROHE			
	SKU No. 2390202.020	P-Number Not on Spec PL-600-LI	Color/Finish White	
	List	Net	Quantity 1	Total
	American Standard Princeton® Recess Bath (Below Floor Installation) Installation Alcove Bath Type Bathing pool Material Americast® brand engineered material, Acid resistant porcelain finish Color / Finish White Installed Size 60 x 30 x 17-1/2" (1524 x 762 x 445 mm) Dimensions 1524 x 762 x 356 mm (60" x 30" x 14")			

STANDARD GUEST ROOMS - TUB/SHOWER COMBO

	SKU No. 2391202.020	P-Number Not on Spec PL-600-LI	Color/Finish White	
	List	Net	Quantity 1	Total
	American Standard Princeton® Recess Bath (Below Floor Installation) Installation Alcove Bath Type Bathing pool Material Americast® brand engineered material, Acid resistant porcelain finish Color / Finish White Installed Size 60 x 30 x 17-1/2" (1524 x 762 x 445 mm) Dimensions 1524 x 762 x 356 mm (60" x 30" x 14")			
	SKU No. 1583.470.002	P-Number Not on Spec PL-600-LI	Color/Finish Polished chrome	
	List	Net	Quantity 1	Total
	American Standard Universal Bathtub Drain Fixture Type Bathtub drain Color / Finish Polished chrome			



STANDARD GUEST ROOMS - TUB/SHOWER COMBO

 	SKU No. 211AA104.020	P-Number Not on Spec PL-300-LI	Color/Finish White	
	List	Net	Quantity 1	Total
	American Standard Champion® Pro Right Height® Elongated Toilet Collection CHAMPION® PRO™ Fixture Type Toilet Toilet Type Tank type Mounting And Waste Floor mounted with floor outlet Toilet Water High Efficiency HET 4.8 LPF (1.28 GPF) Consumption Material Vitreous china Antimicrobial EverClean® antimicrobial surface Color / Finish White Bowl Shape Elongated bowl			
	SKU No. 5257A65MT.020	P-Number Not on Spec PL-302	Color/Finish White	
	List	Net	Quantity 1	Total
	American Standard Toilet Seat For Elongated Bowl Closed Front With Seat Cover Everclean Antimicrobial Surface Toilet Bowl For elongated bowl Application For residential applications Grade Light duty Seat Type Closed front Cover With seat cover Color / Finish White Antimicrobial EverClean® antimicrobial surface			

STANDARD ADA GUEST ROOMS - SHOWER ONLY

	SKU No. 33170003	P-Number Not on Spec PL-200-LI	Color/Finish StarLight chrome
	List	Net	Quantity 1
	GROHE Plus Single Hole Single Handle S-Size Bathroom Faucet Flow Rate 4.5 LPM (1.2 GPM) maximum flowrate Faucet Flow Control GROHE AquaGuide adjustable flow control Operation Manual Number of Handles Single handle Faucet Type Lavatory faucet Color / Finish StarLight chrome EPA WaterSense EPA WaterSense® compliant		
 	SKU No. 0496221.020	P-Number Not on Spec PL-100-LI	Color/Finish White
	List	Net	Quantity 1
	American Standard Ovalyn Undercounter Sink Collection OVALYN Basin Type Lavatory Material Vitreous china Color / Finish White Mounting Counter mounted ADA ANSI A117.1 compliant		

STANDARD ADA GUEST ROOMS - SHOWER ONLY

 	SKU No.	P-Number	Color/Finish
	0630000.020	Not on Spec PL-100-LI	White
	List	Net	Quantity
		1	
American Standard Orbit™ Undercounter Sink Vitreous China			
Barrier Free			
Collection		ORBIT	
Basin Type		Lavatory	
Material		Vitreous china	
Color / Finish		White	
Mounting		Counter mounted	
ADA		ANSI A117.1 compliant	

ALOFT HOTELS - GENERATION 4.0
Marriot Global Design Standards
National Program Guide
May 2023





STANDARD ADA GUEST ROOMS - SHOWER ONLY

	SKU No.	P-Number	Color/Finish
	26043001	Not on Spec PL-400-LI	Starlight chrome
	List	Net	Quantity
		1	
GROHE New Tempesta Cosmopolitan 100 Shower Head 4 Sprays			
ASME Compliance	ASME A112.18.1		
CALGreen Compliance	CALGreen compliant		
CEC	California Energy Commission (CEC) compliant		
Cleaning	SpeedClean® anti-lime system		
Connection	1/2" connection thread		
CSA Compliance	CSA B125.1		
EPA Compliance	Energy Policy Act of 1992		
EPA Watersense	EPA WaterSense®		
Face Diameter	4" face		
Color / Finish	StarLight chrome		
Flow Rate	EcoJoy 2.0 GPM (7.6 l/min) flow limiter		
Function	4 sprays: GROHE Rain O², Rain, Massage and Jet		
Installation	Installed on shower arm		
Manufacturer	GROHE		
Minimum Pressure	103 kPa (15 PSI) minimum recommended pressure		
Shower Head Type	Residential		
Spray	Multispray		
Spray Pattern	DreamSpray perfect spray pattern		
US Federal	US Federal and State material regulations compliant		

ALOFT HOTELS - GENERATION 4.0
Marriot Global Design Standards
National Program Guide
May 2023





STANDARD ADA GUEST ROOMS - SHOWER ONLY

	SKU No. 27414000	P-Number Not on Spec PL-401-LI	Color/Finish Starlight chrome
	List	Net	Quantity 1
	GROHE 5 5/8" Tubular Shower Arm Connection 1/2" Connection thread Color / Finish Starlight chrome Manufacturer GROHE Projection 5-5/8" projection		
	SKU No. 14468000	P-Number Not on Spec PL-801	Color/Finish Starlight chrome
	List	Net	Quantity 1
	GROHE Concetto Pressure Balance Trim With Cartridge Kit Type Valve trim Suggested Rough Valve For use with GrohSafe 3.0 rough-in valves (35 110), (35 111), (35 112), (35 113), (35 114), (35 115), (35 116)		
	SKU No. 35110000	P-Number Not on Spec PL-800-LI	Color/Finish
	List	Net	Quantity 1
	GROHE Pressure Balance Valve Rough With Universal With Service Stops Cartridge Cartridge ships with the trim		



STANDARD ADA GUEST ROOMS - SHOWER ONLY

 	SKU No. 29108001	P-Number Not on Spec PL-801	Color/Finish StarLight chrome	
	List	Net	Quantity 1	Total
	GROHE Concetto 2-Way Diverter Trim (Shower Head/Hand Shower)			
	ADA Color / Finish Fixture Type Handle International Code Council (ICC) Manufacturer Maximum Diverting Outlets Rough Valve	ADA compliant StarLight chrome CONCETTO 2-Way diverter trim (Shower head/Hand shower) Metal lever handle for 2 outlets: shower head/hand shower ICC/ANSI A117.1 GROHE 2 Way For use with 2-way diverter rough-in valves (29 900) or (29 901)		
	SKU No. 29900000	P-Number Not on Spec PL-800	Color/Finish	
	List	Net	Quantity 1	Total
	GROHE 2-Way Diverter Rough-In Valve (Discrete Functions)			
	ADA Compliance ASME Compliance CALGreen Compliance Connection Size CSA Compliance Function Inlet Model Number of Outlets	ADA compliant: requires less than 5 lbs/22.2 N force to operate handle ASME A112.18.1 CALGreen compliant plasterguard included 1/2" NPT CSA B125.1 2 discrete functions 1 inlet 29900 2 outlet		

STANDARD ADA GUEST ROOMS - SHOWER ONLY

	SKU No. 29901000	P-Number Not on Spec PL-800	Color/Finish
	List	Net	Quantity 1
	GROHE 2-Way Diverter Rough-In Valve (Shared Functions) ADA Compliance ADA compliant: requires less than 5 lbs/22.2 N force to operate handle ASME Compliance ASME A112.18.1 Connection plasterguard included 1/2" NPT CSA Compliance CSA B125.1 Inlet 1 inlet Model 29901 Outlet 2 outlets		
	SKU No. 26046002	P-Number Not on Spec PL-402-LI	Color/Finish Starlight chrome
	List	Net	Quantity 1
	GROHE New Tempesta Cosmopolitan 100 Handshower 2 Sprays Flow Rate 1.75 gpm (6.6 l/min) flow limiter Color / Finish StarLight chrome		
	SKU No. 95866000	P-Number Not on Spec PL-402-LI	Color/Finish Starlight chrome
	List	Net	Quantity 1
	GROHE Volume Control For Shower Heads & Hand Showers ANSI Compliance ICC/ANSI A117.1 Color / Finish Starlight chrome Flow Rate Adjusts from 2.5 GPM to a trickle flow Non-Positive Shutoff Non-Positive shutoff		



STANDARD ADA GUEST ROOMS - SHOWER ONLY

	SKU No.	P-Number	Color/Finish
	1660730.002	Not on Spec PL-402-LI	Polished chrome
	List	Net	Quantity
		1	
American Standard 30 Inch Round Shower Slide Bar			
Color / Finish	Polished chrome		
Fixture Type	SLIDE BAR		
Length	805 mm (31-11/16") long		
Manufacturer	American Standard		
Model	Adjustable shower holder can be set at any height or position along the bar and angles up to 45 degrees		
Model Type	STANDARD		
Width	124 mm (4-7/8") wide		
	SKU No.	P-Number	Color/Finish
	28025000	Not on Spec PL-402-LI	Starlight chrome
	List	Net	Quantity
		1	
GROHE Rotaflex Metal Longlife			
Connection	Universal connection G 1/2" x 1/2" inlets and outlets		
Cover	Removable protection cover with installation information		
Color / Finish	Starlight chrome		
Function	Rotation cone for Twist-free function		
Length	1753 mm (69") long		
Material	Metal		
Pressure Resistance	Pressure resistance: up to 16 bar		
Stops	Silicone strip prevents hand shower from turning while in body spray position		
Tensile Strength	Tensile strength 500 N		

ALOFT HOTELS - GENERATION 4.0
Marriot Global Design Standards
National Program Guide
May 2023



STANDARD ADA GUEST ROOMS - SHOWER ONLY

	SKU No. 28672000	P-Number Not on Spec PL-402-LI	Color/Finish Starlight chrome	
	List	Net	Quantity 1	Total
	GROHE Shower Outlet Elbow, 1/2" Collection RELAXA Connection Type 1/2" NPT Female Threads Color / Finish StarLight chrome Manufacturer GROHE			
	SKU No. 07911000	P-Number Not on Spec PL-402-LI	Color/Finish Starlight chrome	
	List	Net	Quantity 1	Total
	GROHE 1/2" Inline Vacuum Breaker Application Inline Color / Finish Starlight chrome Fixture Type Vacuum breaker Manufacturer GROHE Size 13 mm (1/2")			



STANDARD ADA GUEST ROOMS - SHOWER ONLY

 	SKU No. 211AA104.020	P-Number Not on Spec PL-300-LI	Color/Finish White	
	List	Net	Quantity 1	Total
	American Standard Champion® Pro Right Height® Elongated Toilet Collection CHAMPION® PRO™ Fixture Type Toilet Toilet Type Tank type Mounting And Waste Floor mounted with floor outlet Toilet Water Consumption High Efficiency HET 4.8 LPF (1.28 GPF) Material Vitreous china Antimicrobial EverClean® antimicrobial surface Color / Finish White Bowl Shape Elongated bowl			
	SKU No. 5257A65MT.020	P-Number Not on Spec PL-302	Color/Finish White	
	List	Net	Quantity 1	Total
	American Standard Toilet Seat For Elongated Bowl Closed Front With Seat Cover Everclean Antimicrobial Surface Toilet Bowl For elongated bowl Application For residential applications Grade Light duty Seat Type Closed front Cover With seat cover Color / Finish White Antimicrobial EverClean® antimicrobial surface			

STANDARD ADA GUEST ROOMS - TUB/SHOWER COMBO

	SKU No. 33170003	P-Number Not on Spec PL-200-LI	Color/Finish Starlight chrome	
	List	Net	Quantity 1	Total
	GROHE Plus Single Hole Single Handle S-Size Bathroom Faucet Flow Rate 4.5 LPM (1.2 GPM) maximum flowrate Faucet Flow Control GROHE AquaGuide adjustable flow control Operation Manual Number of Handles Single handle Faucet Type Lavatory faucet Color / Finish StarLight chrome EPA WaterSense EPA WaterSense® compliant			
 	SKU No. 0496221.020	P-Number Not on Spec PL-100-LI	Color/Finish White	
	List	Net	Quantity 1	Total
	American Standard Ovalyn Undercounter Sink Collection OVALYN Basin Type Lavatory Material Vitreous china Color / Finish White Mounting Counter mounted ADA ANSI A117.1 compliant			

STANDARD ADA GUEST ROOMS - TUB/SHOWER COMBO

 	SKU No.	P-Number	Color/Finish
	0630000.020		White
	List	Net	Quantity
		1	
American Standard Orbit™ Undercounter Sink Vitreous China			
Barrier Free			
Collection		ORBIT	
Basin Type		Lavatory	
Material		Vitreous china	
Color / Finish		White	
Mounting		Counter mounted	
ADA		ANSI A117.1 compliant	

STANDARD ADA GUEST ROOMS - TUB/SHOWER COMBO

	SKU No.	P-Number	Color/Finish
	26043001	Not on Spec PL-400	Starlight chrome
	List	Net	Quantity
		1	
GROHE New Tempesta Cosmopolitan 100 Shower Head 4 Sprays			
ASME Compliance	ASME A112.18.1		
CALGreen Compliance	CALGreen compliant		
CEC	California Energy Commission (CEC) compliant		
Cleaning	SpeedClean® anti-lime system		
Connection	1/2" connection thread		
CSA Compliance	CSA B125.1		
EPA Compliance	Energy Policy Act of 1992		
EPA Watersense	EPA WaterSense®		
Face Diameter	4" face		
Color / Finish	StarLight chrome		
Flow Rate	EcoJoy 2.0 GPM (7.6 l/min) flow limiter		
Function	4 sprays: GROHE Rain O ² , Rain, Massage and Jet		
Installation	Installed on shower arm		
Manufacturer	GROHE		
Minimum Pressure	103 kPa (15 PSI) minimum recommended pressure		
Shower Head Type	Residential		
Spray	Multispray		
Spray Pattern	DreamSpray perfect spray pattern		
US Federal	US Federal and State material regulations compliant		

ALOFT HOTELS - GENERATION 4.0
Marriot Global Design Standards
National Program Guide
May 2023



STANDARD ADA GUEST ROOMS - TUB/SHOWER COMBO

	SKU No. 27414000	P-Number Not on Spec PL-401	Color/Finish Starlight chrome
	List	Net	Quantity 1
	GROHE 5 5/8" Tubular Shower Arm Connection 1/2" Connection thread Color / Finish Starlight chrome Manufacturer GROHE Projection 5-5/8" projection		
	SKU No. 14468000	P-Number Not on Spec PL-801	Color/Finish Starlight Chrome
	List	Net	Quantity 1
	GROHE Concetto Pressure Balance Trim With Cartridge Kit Type Valve trim Suggested Rough Valve For use with GrohSafe 3.0 rough-in valves (35 110), (35 111), (35 112), (35 113), (35 114), (35 115), (35 116)		
	SKU No. 35110000	P-Number Not on Spec PL-800-LI	Color/Finish
	List	Net	Quantity 1
	GROHE Pressure Balance Valve Rough With Universal With Service Stops Cartridge Cartridge ships with the trim		



STANDARD ADA GUEST ROOMS - TUB/SHOWER COMBO

 	SKU No. 29108001	P-Number Not on Spec PL-801	Color/Finish Starlight chrome	
	List	Net	Quantity 1	Total
	GROHE Concetto 2-Way Diverter Trim (Shower Head/Hand Shower)			
	ADA Color / Finish Fixture Type Handle International Code Council (ICC) Manufacturer Maximum Diverting Outlets Rough Valve	ADA compliant StarLight chrome CONCETTO 2-Way diverter trim (Shower head/Hand shower) Metal lever handle for 2 outlets: shower head/hand shower ICC/ANSI A117.1 GROHE 2 Way For use with 2-way diverter rough-in valves (29 900) or (29 901)		
	SKU No. 29900000	P-Number Not on Spec PL-800	Color/Finish	
	List	Net	Quantity 1	Total
	GROHE 2-Way Diverter Rough-In Valve (Discrete Functions)			
	ADA Compliance ASME Compliance CALGreen Compliance Connection Size CSA Compliance Function Inlet Model Number of Outlets	ADA compliant: requires less than 5 lbs/22.2 N force to operate handle ASME A112.18.1 CALGreen compliant plasterguard included 1/2" NPT CSA B125.1 2 discrete functions 1 inlet 29900 2 outlet		



ALOFT HOTELS - GENERATION 4.0
Marriot Global Design Standards
National Program Guide
May 2023





STANDARD ADA GUEST ROOMS - TUB/SHOWER COMBO

	SKU No. 26046002	P-Number Not on Spec PL-402-LI	Color/Finish Starlight chrome
	List	Net	Quantity 1
	GROHE New Tempesta Cosmopolitan 100 Handshower 2 Sprays Flow Rate 1.75 gpm (6.6 l/min) flow limiter Color / Finish StarLight chrome		
	SKU No. 95866000	P-Number Not on Spec PL-402-LI	Color/Finish Starlight chrome
	List	Net	Quantity 1
	GROHE Volume Control For Shower Heads & Hand Showers ANSI Compliance ICC/ANSI A117.1 Color / Finish Starlight chrome Flow Rate Adjusts from 2.5 GPM to a trickle flow Non-Positive Shutoff Non-Positive shutoff		
	SKU No. 1660730.002	P-Number Not on Spec PL-402-LI	Color/Finish Polished chrome
	List	Net	Quantity 1
	American Standard 30 Inch Round Shower Slide Bar Color / Finish Polished chrome Fixture Type SLIDE BAR Length 805 mm (31-11/16") long Manufacturer American Standard Model Adjustable shower holder can be set at any height or position along the bar and angles up to 45 degrees Model Type STANDARD Width 124 mm (4-7/8") wide		



STANDARD ADA GUEST ROOMS - TUB/SHOWER COMBO

	SKU No. 28025000	P-Number Not on Spec PL-402-LI	Color/Finish Starlight chrome
	List	Net	Quantity 1
	GROHE Rotaflex Metal Longlife		
	Connection	Universal connection G 1/2" x 1/2" inlets and outlets	
	Cover	Removable protection cover with installation information	
	Color / Finish	Starlight chrome	
	Function	Rotation cone for Twist-free function	
	Length	1753 mm (69") long	
	Material	Metal	
	Pressure Resistance	Pressure resistance: up to 16 bar	
	Stops	Silicone strip prevents hand shower from turning while in body spray position	
	Tensile Strength	Tensile strength 500 N	
	SKU No. 28672000	P-Number Not on Spec PL-403-LI	Color/Finish Starlight chrome
	List	Net	Quantity 1
	GROHE Shower Outlet Elbow, 1/2"		
	Collection	RELAXA	
	Connection Type	1/2" NPT Female Threads	
	Color / Finish	StarLight chrome	
	Manufacturer	GROHE	

STANDARD ADA GUEST ROOMS - TUB/SHOWER COMBO

	SKU No.	P-Number	Color/Finish
	07911000	Not on Spec PL-402-LI	Starlight chrome
	List	Net	Quantity
1			
GROHE 1/2" Inline Vacuum Breaker			
Application	Inline		
Color / Finish	Starlight chrome		
Fixture Type	Vacuum breaker		
Manufacturer	GROHE		
Size	13 mm (1/2")		
	SKU No.	P-Number	Color/Finish
	13274001	Not on Spec PL-600-LI	Starlight chrome
	List	Net	Quantity
1			
GROHE Tub Spout			
Collection	CONCETTO		
Compliances and Certifications	Energy Policy Act of 1992, ASME A112.18.1/CSA B125.1, EPACT92 compliant, ICC/ANSI A117.1 compliant		
Discharge Type	Flow control		
Diverter	Non diverter tub spout		
Color / Finish	StarLight Chrome		
Manufacturer	GROHE		
Mounting	Wall-hung		
Projection	170 mm (6-11/16")		
Thread	13 mm (1/2") NPT Male Threads		
Thread Size	1/2		
Type	Tub spout		

STANDARD ADA GUEST ROOMS - TUB/SHOWER COMBO

	SKU No. 2390202.020	P-Number Not on Spec PL-600-LI	Color/Finish White
	List	Net	Quantity 1
	American Standard Princeton® Recess Bath (Below Floor Installation)		
	Installation	Alcove	
	Bath Type	Bathing pool	
	Material	Americast® brand engineered material, Acid resistant porcelain finish	
	Color / Finish	White	
	Installed Size	60 x 30 x 17-1/2" (1524 x 762 x 445 mm)	
	Dimensions	1524 x 762 x 356 mm (60" x 30" x 14")	
	SKU No. 2391202.020	P-Number Not on Spec PL-600-LI	Color/Finish White
	List	Net	Quantity 1
	American Standard Princeton® Recess Bath (Below Floor Installation)		
	Installation	Alcove	
	Bath Type	Bathing pool	
	Material	Americast® brand engineered material, Acid resistant porcelain finish	
	Color / Finish	White	
	Installed Size	60 x 30 x 17-1/2" (1524 x 762 x 445 mm)	
	Dimensions	1524 x 762 x 356 mm (60" x 30" x 14")	
	SKU No. 1640305.002	P-Number	Color/Finish Polished chrome
	List	Net	Quantity 1
	American Standard Deep Soak® Bathtub Drain		
	Fixture Type	Bathtub drain	
	Color / Finish	Polished chrome	

STANDARD ADA GUEST ROOMS - TUB/SHOWER COMBO

 	SKU No. 211AA104.020	P-Number Not on Spec PL-300-LI	Color/Finish White	
	List	Net	Quantity 1	Total
	American Standard Champion® Pro Right Height® Elongated Toilet Collection CHAMPION® PRO™ Fixture Type Toilet Toilet Type Tank type Mounting And Waste Floor mounted with floor outlet Toilet Water High Efficiency HET 4.8 LPF (1.28 GPF) Consumption Material Vitreous china Antimicrobial EverClean® antimicrobial surface Color / Finish White Bowl Shape Elongated bowl			
	SKU No. 5257A65MT.020	P-Number Not on Spec PL-302	Color/Finish White	
	List	Net	Quantity 1	Total
	American Standard Toilet Seat For Elongated Bowl Closed Front With Seat Cover Everclean Antimicrobial Surface Toilet Bowl For elongated bowl Application For residential applications Grade Light duty Seat Type Closed front Cover With seat cover Color / Finish White Antimicrobial EverClean® antimicrobial surface			

Related Literature



Residential Fixtures and Faucets List Price Guide 2022



2021 LIXIL Builder Advantage Program Brochure



Ultima® Diaphragm Flush Valves Sell Sheet

Find Our Products Here

REVIT, Specs, CAD and BIM Availability

Through our partner ATS, American Standard Brands provides a complete plumbing specification solution for your Revit and 3D projects. With over 8,500 product combinations accessible for immediate download and new files being added daily, ATS is the largest source for Revit plumbing equipment. ATS and American Standard’s combined 3D BIM families can be easily accessed and downloaded at no-cost to the specification design community. For more information, please visit our partner website, www.atsspec.net.

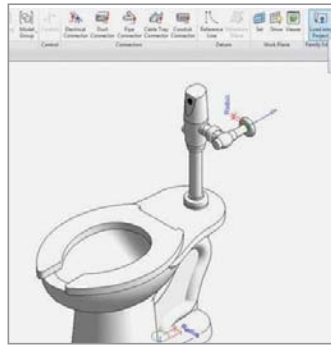

Revit Families Available

Our products are specified in
SpecLink
www.bsdspeclink.com



For American Standard Customer Care

Call 1-800-442-1902 – Monday – Friday, 8:00 am – 7:00 pm EST

Visit www.americanstandard.com

Front Cover: Cadet® Touchless Chair Height Elongated Toilet Less Seat - 215AA709.002