

**FAIRFIELD INN - GENERATION 4.5**

Marriott Global Design Standard

National Program Guide

May 2023



*American  
Standard*

DXXV



INAX

PART OF **LIXIL**



# ENERGY CONSERVATION ENERGY CREATION

Mega-solar power plant at the **LIXIL** Chita Plant in Japan

**LIXIL** is the most **comprehensive global company in the housing and building industry**. We provide **human-centric innovations** that **enhance** people's living space. From **sanitary fixtures** and **fittings** to a **full line-up** of materials for **residential and commercial**. We bring to market **beautiful design, reliable quality, innovation, environmentally-friendly products** with a **responsible approach to business and the planet**.







**LIXIL** Link to  
Good Living

# FAIRFIELD INN - GENERATION 4.5

Marriott Global Design Standard  
May 2023



## SHOWER ONLY (STANDARD LAYOUT 1)

    	<b>SKU No.</b> 2312900A	<b>P-Number</b> NOT ON SPEC PL-202-LI_SNK-04	<b>Color/Finish</b> StarLight chrome	
	<b>List</b>	<b>Net</b>	<b>Quantity</b> 1	<b>Total</b>
	<b>GROHE Single-Handle Bathroom Faucet S-Size</b> Collection EUROCUBE Flow Rate 4.5 LPM (1.2 GPM) maximum flowrate Faucet Flow Control GROHE EcoJoy Mousseur Operation Manual Number of Handles Single handle Faucet Type Lavatory faucet Color / Finish StarLight chrome EPA WaterSense EPA WaterSense® compliant			
 	<b>SKU No.</b> 0614000.020	<b>P-Number</b> PL-103-LI_SNK-04	<b>Color/Finish</b> White finish	
	<b>List</b>	<b>Net</b>	<b>Quantity</b> 1	<b>Total</b>
	<b>American Standard Studio Undercounter Sink</b> Collection STUDIO Basin Type Lavatory Material Vitreous china Color / Finish White finish Mounting Counter mounted ADA ANSI A117.1 compliant			

# FAIRFIELD INN - GENERATION 4.5

Marriott Global Design Standard  
May 2023



## SHOWER ONLY (STANDARD LAYOUT 1)

	<b>SKU No.</b>	<b>P-Number</b>	<b>Color/Finish</b>
	26043001	NOT ON SPEC PL-401-A1-LI_SHR-02	StarLight chrome
	<b>List</b>	<b>Net</b>	<b>Quantity</b>
			1
	<b>GROHE New Tempesta Cosmopolitan 100 Shower Head 4 Sprays</b>		
	ASME Compliance	ASME A112.18.1	
	CALGreen Compliance	CALGreen compliant	
	CEC	California Energy Commission (CEC) compliant	
	Cleaning	SpeedClean® anti-lime system	
	Connection	1/2" connection thread	
	CSA Compliance	CSA B125.1	
	EPA Compliance	Energy Policy Act of 1992	
	EPA Watersense	EPA WaterSense®	
	Face Diameter	4" face	
	Color / Finish	StarLight chrome	
	Flow Rate	EcoJoy 2.0 GPM (7.6 l/min) flow limiter	
	Function	4 sprays: GROHE Rain O <sup>2</sup> , Rain, Massage and Jet	
	Installation	Installed on shower arm	
	Manufacturer	GROHE	
	Minimum Pressure	103 kPa (15 PSI) minimum recommended pressure	
	Shower Head Type	Residential	
	Spray	Multispray	
	Spray Pattern	DreamSpray perfect spray pattern	
	US Federal	US Federal and State material regulations compliant	









# FAIRFIELD INN - GENERATION 4.5

Marriott Global Design Standard  
May 2023



## SHOWER ONLY (STANDARD LAYOUT 1)



     	<b>SKU No.</b> 9038074.002	<b>P-Number</b> NOT ON SPEC PL-401-A1-LI_SHR-02	<b>Color/Finish</b> Polished chrome
	<b>List</b>	<b>Net</b>	<b>Quantity</b> 1
	<b>SKU No.</b> 14469000	<b>P-Number</b> NOT ON SPEC PL-803-LI_SHR-01	<b>Color/Finish</b> StarLight chrome
	<b>List</b>	<b>Net</b>	<b>Quantity</b> 1

# FAIRFIELD INN - GENERATION 4.5

Marriott Global Design Standard  
May 2023



## SHOWER ONLY (STANDARD LAYOUT 1)

	<b>SKU No.</b> 35110000	<b>P-Number</b> NOT ON SPEC PL-803-LI_SHR-01	<b>Color/Finish</b>	
	<b>List</b>	<b>Net</b>	<b>Quantity</b> 1	<b>Total</b>
	<b>GROHE Pressure Balance Valve Rough With Universal With Service Stops</b> Cartridge                      Cartridge ships with the trim			
	<b>SKU No.</b> 26633000	<b>P-Number</b> NOT SPEC PL-803-LI_SHR-01	<b>Color/Finish</b> StarLight chrome	
	<b>List</b>	<b>Net</b>	<b>Quantity</b> 1	<b>Total</b>
	<b>GROHE Relexa Shower Wall Union, 1/2"</b> CEC                                      CEC Compliances and                      ASME A112.18.1/CSA B125.1 Certifications Connection                              1/2" NPT connection thread(s) CSA Compliance                      CSA B125.1 Escutcheon                              With square escutcheon Color / Finish                              StarLight chrome Manufacturer                              GROHE Material                                      Metal Shower Arm                              152 mm (6") shower arm UPC    cUPC compliant			

# FAIRFIELD INN - GENERATION 4.5

Marriott Global Design Standard  
May 2023



## SHOWER ONLY (STANDARD LAYOUT 1)

	<b>SKU No.</b> 215AA104.020	<b>P-Number</b> NOT ON SPEC PL-301-LI_WCL-04	<b>Color/Finish</b> White	
	<b>List</b>	<b>Net</b>	<b>Quantity</b> 1	<b>Total</b>
	<b>American Standard Cadet® Pro™ Right Height® Elongated Toilet</b> Collection CADET® PRO™ Fixture Type Toilet Toilet Type Tank type Mounting And Waste Floor mounted with floor outlet Toilet Water Consumption High Efficiency HET 4.8 LPF (1.28 GPF) Material Vitreous china Antimicrobial EverClean® antimicrobial surface Color / Finish White Bowl Shape Elongated bowl			
	<b>SKU No.</b> 211AA104.020	<b>P-Number</b> NOT ON SPEC PL-301-LI_WCL-04	<b>Color/Finish</b> White	
	<b>List</b>	<b>Net</b>	<b>Quantity</b> 1	<b>Total</b>
	<b>American Standard Champion® Pro Right Height® Elongated Toilet</b> Collection CHAMPION® PRO™ Fixture Type Toilet Toilet Type Tank type Mounting And Waste Floor mounted with floor outlet Toilet Water Consumption High Efficiency HET 4.8 LPF (1.28 GPF) Material Vitreous china Antimicrobial EverClean® antimicrobial surface Color / Finish White Bowl Shape Elongated bowl			



**FAIRFIELD INN - GENERATION 4.5**

Marriott Global Design Standard  
May 2023



SHOWER ONLY (STANDARD LAYOUT 1)







	<b>SKU No.</b> 5503A00B.020	<b>P-Number</b> NOT ON SPEC PL-302-LI_WCL-04	<b>Color/Finish</b> White	
	<b>List</b>	<b>Net</b>	<b>Quantity</b> 1	<b>Total</b>
	<b>American Standard Toilet Seat For Round Bowl With Seat Cover</b> Toilet Bowl For elongated bowl Application For residential applications Grade Standard Cover With seat cover Color / Finish White			

# FAIRFIELD INN - GENERATION 4.5

Marriott Global Design Standard  
May 2023



## TUB/SHOWER COMBO (STANDARD LAYOUT 2)

    	<b>SKU No.</b> 2312900A	<b>P-Number</b> NOT ON SPEC PL-202-LI_SNK-04	<b>Color/Finish</b> StarLight chrome	
	<b>List</b>	<b>Net</b>	<b>Quantity</b> 1	<b>Total</b>
	<b>GROHE Single-Handle Bathroom Faucet S-Size</b> Collection EURO CUBE Flow Rate 4.5 LPM (1.2 GPM) maximum flowrate Faucet Flow Control GROHE EcoJoy Mousseur Operation Manual Number of Handles Single handle Faucet Type Lavatory faucet Color / Finish StarLight chrome EPA WaterSense EPA WaterSense® compliant			
 	<b>SKU No.</b> 0614000.020	<b>P-Number</b> PL-103-LI_SNK-04	<b>Color/Finish</b> White finish	
	<b>List</b>	<b>Net</b>	<b>Quantity</b> 1	<b>Total</b>
	<b>American Standard Studio Undercounter Sink</b> Collection STUDIO Basin Type Lavatory Material Vitreous china Color / Finish White finish Mounting Counter mounted ADA ANSI A117.1 compliant			

# FAIRFIELD INN - GENERATION 4.5

Marriott Global Design Standard  
May 2023



## TUB/SHOWER COMBO (STANDARD LAYOUT 2)







	<b>SKU No.</b>	<b>P-Number</b>	<b>Color/Finish</b>
	26043001	NOT ON SPEC PL-401-A1-LI_TUB-01	StarLight chrome
	<b>List</b>	<b>Net</b>	<b>Quantity</b>
			1
	<b>GROHE New Tempesta Cosmopolitan 100 Shower Head 4 Sprays</b>		
	<p>ASME Compliance ASME A112.18.1</p> <p>CALGreen Compliance CALGreen compliant</p> <p>CEC California Energy Commission (CEC) compliant</p> <p>Cleaning SpeedClean® anti-lime system</p> <p>Connection 1/2" connection thread</p> <p>CSA Compliance CSA B125.1</p> <p>EPA Compliance Energy Policy Act of 1992</p> <p>EPA Watersense EPA WaterSense®</p> <p>Face Diameter 4" face</p> <p>Color / Finish StarLight chrome</p> <p>Flow Rate EcoJoy 2.0 GPM (7.6 l/min) flow limiter</p> <p>Function 4 sprays: GROHE Rain O<sup>2</sup>, Rain, Massage and Jet</p> <p>Installation Installed on shower arm</p> <p>Manufacturer GROHE</p> <p>Minimum Pressure 103 kPa (15 PSI) minimum recommended pressure</p> <p>Shower Head Type Residential</p> <p>Spray Multispray</p> <p>Spray Pattern DreamSpray perfect spray pattern</p> <p>US Federal US Federal and State material regulations compliant</p>		
  			

# FAIRFIELD INN - GENERATION 4.5

Marriott Global Design Standard  
May 2023



## TUB/SHOWER COMBO (STANDARD LAYOUT 2)

     	<b>SKU No.</b> 9038074.002	<b>P-Number</b> NOT ON SPEC PL-401-A2-LI_TUB-01	<b>Color/Finish</b> Polished chrome	
	<b>List</b>	<b>Net</b>	<b>Quantity</b> 1	<b>Total</b>
	<b>American Standard Spectra+™ 4-Function Showerhead</b> Compliances and Certifications ASME A112.18.1, CSA B125.1 Color / Finish Polished chrome Flow Control Device Provides consistent flow over a wide pressure range Flow Rate 1.8 GPM (6.8 LPM) showerhead flowrate Function 4-Function (Drench to Sensitive to Jet to Massage) Installation Installed on shower arm Manufacturer American Standard Model Type Showerhead Shower Head Type Residential Spray Allows the user to select the type of spray best suited to their needs EPA WaterSense EPA WaterSense® compliant			
	<b>SKU No.</b> 14469000	<b>P-Number</b> NOT ON SPEC PL-801-LI_TUB-01	<b>Color/Finish</b> StarLight chrome	
	<b>List</b>	<b>Net</b>	<b>Quantity</b> 1	<b>Total</b>
	<b>GROHE Eurocube Cosmopolitan Pressure Balance Valve Trim With Cartridge</b> Kit Type Valve trim			

# FAIRFIELD INN - GENERATION 4.5

Marriott Global Design Standard  
May 2023



## TUB/SHOWER COMBO (STANDARD LAYOUT 2)

	<b>SKU No.</b> 35110000	<b>P-Number</b> NOT ON SPEC PL-801-LI_TUB-01	<b>Color/Finish</b>
	<b>List</b>	<b>Net</b>	<b>Quantity</b> 1
	<b>GROHE Pressure Balance Valve Rough With Universal With Service Stops</b> Cartridge                      Cartridge ships with the trim		
	<b>SKU No.</b> 13366000	<b>P-Number</b> NOT ON SPEC PL-801-LI_TUB-01	<b>Color/Finish</b> StarLight chrome
	<b>List</b>	<b>Net</b>	<b>Quantity</b> 1
	<b>GROHE Concetto Diverter Tub Spout</b> Diverter                      Diverter Tub Spout Color / Finish              StarLight chrome Installation                  SlipFit installation Manufacturer                GROHE		

# FAIRFIELD INN - GENERATION 4.5

Marriott Global Design Standard  
May 2023



## TUB/SHOWER COMBO (STANDARD LAYOUT 2)



	<b>SKU No.</b> 26633000	<b>P-Number</b> NOT ON SPEC PL-801-LI_TUB-01	<b>Color/Finish</b> StarLight chrome	
	<b>List</b>	<b>Net</b>	<b>Quantity</b> 1	<b>Total</b>
	<b>GROHE Relexa Shower Wall Union, 1/2"</b> CEC CEC Compliances and Certifications ASME A112.18.1/CSA B125.1 Connection 1/2" NPT connection thread(s) CSA Compliance CSA B125.1 Escutcheon With square escutcheon Color / Finish StarLight chrome Manufacturer GROHE Material Metal Shower Arm 152 mm (6") shower arm UPC cUPC compliant			
  	<b>SKU No.</b> 2390.202.020	<b>P-Number</b> PL-601-LI-TUB-01	<b>Color/Finish</b> White	
	<b>List</b>	<b>Net</b>	<b>Quantity</b> 1	<b>Total</b>
	<b>American Standard Princeton® Recess Bath (Below Floor Installation)</b> Installation Alcove Bath Type Bathing pool Material Americast® brand engineered material, Acid resistant porcelain finish Color / Finish White Installed Size 60 x 30 x 17-1/2" (1524 x 762 x 445 mm) Dimensions 1524 x 762 x 356 mm (60" x 30" x 14")			

# FAIRFIELD INN - GENERATION 4.5

Marriott Global Design Standard  
May 2023



## TUB/SHOWER COMBO (STANDARD LAYOUT 2)

 	<b>SKU No.</b> 2391.202.020	<b>P-Number</b> PL-601-LI-TUB-01	<b>Color/Finish</b> White	
	<b>List</b>	<b>Net</b>	<b>Quantity</b> 1	<b>Total</b>
	<b>American Standard Princeton® Recess Bath (Below Floor Installation)</b> Installation Alcove Bath Type Bathing pool Material Americast® brand engineered material, Acid resistant porcelain finish Color / Finish White Installed Size 60 x 30 x 17-1/2" (1524 x 762 x 445 mm) Dimensions 1524 x 762 x 356 mm (60" x 30" x 14")			
	<b>SKU No.</b> 1640.305.002	<b>P-Number</b> PL-901-LI_TUB-01	<b>Color/Finish</b> Polished chrome	
	<b>List</b>	<b>Net</b>	<b>Quantity</b> 1	<b>Total</b>
	<b>American Standard Deep Soak® Bathtub Drain</b> Fixture Type Bathtub drain Color / Finish Polished chrome			

# FAIRFIELD INN - GENERATION 4.5

Marriott Global Design Standard  
May 2023



## TUB/SHOWER COMBO (STANDARD LAYOUT 2)

 	<b>SKU No.</b> 215AA104.020	<b>P-Number</b> NOT ON SPEC PL-301-LI_WCL-04	<b>Color/Finish</b> White	
	<b>List</b>	<b>Net</b>	<b>Quantity</b> 1	<b>Total</b>
	<b>American Standard Cadet® Pro™ Right Height® Elongated Toilet</b> Collection CADET® PRO™ Fixture Type Toilet Toilet Type Tank type Mounting And Waste Floor mounted with floor outlet Toilet Water Consumption High Efficiency HET 4.8 LPF (1.28 GPF) Material Vitreous china Antimicrobial EverClean® antimicrobial surface Color / Finish White Bowl Shape Elongated bowl			
 	<b>SKU No.</b> 211AA104.020	<b>P-Number</b> NOT ON SPEC PL-301-LI_WCL-04	<b>Color/Finish</b> White	
	<b>List</b>	<b>Net</b>	<b>Quantity</b> 1	<b>Total</b>
	<b>American Standard Champion® Pro Right Height® Elongated Toilet</b> Collection CHAMPION® PRO™ Fixture Type Toilet Toilet Type Tank type Mounting And Waste Floor mounted with floor outlet Toilet Water Consumption High Efficiency HET 4.8 LPF (1.28 GPF) Material Vitreous china Antimicrobial EverClean® antimicrobial surface Color / Finish White Bowl Shape Elongated bowl			

# FAIRFIELD INN - GENERATION 4.5

Marriott Global Design Standard  
May 2023



## TUB/SHOWER COMBO (STANDARD LAYOUT 2)







	<b>SKU No.</b>	<b>P-Number</b>	<b>Color/Finish</b>
	5503A00B.020	NOT ON SPEC PL-302-LI_WCL-04	White
	<b>List</b>	<b>Net</b>	<b>Quantity</b>
<b>American Standard Toilet Seat For Round Bowl With Seat Cover</b>			
Toilet Bowl		For elongated bowl	
Application		For residential applications	
Grade		Standard	
Cover		With seat cover	
Color / Finish		White	

# FAIRFIELD INN - GENERATION 4.5

Marriott Global Design Standard  
May 2023



## ADA SHOWER ONLY (ADA SHOWER LAYOUT 3)

    	<b>SKU No.</b> 2312900A	<b>P-Number</b> NOT ON SPEC PL-202-LI_SNK-04	<b>Color/Finish</b> StarLight chrome	
	<b>List</b>	<b>Net</b>	<b>Quantity</b> 1	<b>Total</b>
	<b>GROHE Single-Handle Bathroom Faucet S-Size</b>			
	Collection	EUROCUBE		
	Flow Rate	4.5 LPM (1.2 GPM) maximum flowrate		
	Faucet Flow Control	GROHE EcoJoy Mousseur		
	Operation	Manual		
	Number of Handles	Single handle		
	Faucet Type	Lavatory faucet		
	Color / Finish	StarLight chrome		
	EPA WaterSense	EPA WaterSense® compliant		
 	<b>SKU No.</b> 0614000.020	<b>P-Number</b> PL-103-LI_SNK-05	<b>Color/Finish</b> White finish	
	<b>List</b>	<b>Net</b>	<b>Quantity</b> 1	<b>Total</b>
	<b>American Standard Studio Undercounter Sink</b>			
	Collection	STUDIO		
	Basin Type	Lavatory		
	Material	Vitreous china		
	Color / Finish	White finish		
	Mounting	Counter mounted		
	ADA	ANSI A117.1 compliant		

# FAIRFIELD INN - GENERATION 4.5

Marriott Global Design Standard  
May 2023



## ADA SHOWER ONLY (ADA SHOWER LAYOUT 3)

	<b>SKU No.</b>	<b>P-Number</b>	<b>Color/Finish</b>
	26043001	NOT ON SPEC PL-401-A1-LI_SHR-02	StarLight chrome
	<b>List</b>	<b>Net</b>	<b>Quantity</b>
			1
	<b>GROHE New Tempesta Cosmopolitan 100 Shower Head 4 Sprays</b>		
	ASME Compliance	ASME A112.18.1	
	CALGreen Compliance	CALGreen compliant	
	CEC	California Energy Commission (CEC) compliant	
	Cleaning	SpeedClean® anti-lime system	
	Connection	1/2" connection thread	
	CSA Compliance	CSA B125.1	
	EPA Compliance	Energy Policy Act of 1992	
	EPA Watersense	EPA WaterSense®	
	Face Diameter	4" face	
	Color / Finish	StarLight chrome	
	Flow Rate	EcoJoy 2.0 GPM (7.6 l/min) flow limiter	
	Function	4 sprays: GROHE Rain O <sup>2</sup> , Rain, Massage and Jet	
	Installation	Installed on shower arm	
	Manufacturer	GROHE	
	Minimum Pressure	103 kPa (15 PSI) minimum recommended pressure	
	Shower Head Type	Residential	
	Spray	Multispray	
	Spray Pattern	DreamSpray perfect spray pattern	
	US Federal	US Federal and State material regulations compliant	





# FAIRFIELD INN - GENERATION 4.5

Marriott Global Design Standard  
May 2023



## ADA SHOWER ONLY (ADA SHOWER LAYOUT 3)





 	<b>SKU No.</b> 29422000	<b>P-Number</b> NOT ON SPEC PL-803-LI_SHR-02	<b>Color/Finish</b> StarLight chrome	
	<b>List</b>	<b>Net</b>	<b>Quantity</b> 1	<b>Total</b>
	<b>GROHE Eurocube® Pressure Balance Valve Trim With 2-Way Diverter With Cartridge</b> Kit Type                      Valve trim Color / Finish                StarLight chrome ADA                                ADA compliant			
	<b>SKU No.</b> 35117000	<b>P-Number</b> NOT ON SPEC PL-803-LI_SHR-02	<b>Color/Finish</b>	
	<b>List</b>	<b>Net</b>	<b>Quantity</b> 1	<b>Total</b>
	<b>GROHE Grohsafe™ Pressure Balance Rough-In Valve With Integrated Diverter</b> Model Type                    Pressure Balance valve			

# FAIRFIELD INN - GENERATION 4.5

Marriott Global Design Standard  
May 2023



## ADA SHOWER ONLY (ADA SHOWER LAYOUT 3)

	<b>SKU No.</b> 26633000	<b>P-Number</b> NOT ON SPEC PL-803-LI_SHR-02	<b>Color/Finish</b> StarLight chrome	
	<b>List</b>	<b>Net</b>	<b>Quantity</b> 1	<b>Total</b>
	<b>GROHE Relexa Shower Wall Union, 1/2"</b>			
	CEC Compliances and Certifications Connection CSA Compliance Escutcheon Color / Finish Manufacturer Material Shower Arm UPC	CEC ASME A112.18.1/CSA B125.1  1/2" NPT connection thread(s) CSA B125.1 With square escutcheon StarLight chrome GROHE Metal 152 mm (6") shower arm cUPC compliant		
   	<b>SKU No.</b> 26076002	<b>P-Number</b> NOT ON SPEC PL-404-LI_SHR-01	<b>Color/Finish</b> StarLight chrome	
	<b>List</b>	<b>Net</b>	<b>Quantity</b> 1	<b>Total</b>
	<b>GROHE New Tempesta Cosmopolitan 100 Shower Rail Set 2 Sprays</b>			
	Color / Finish	StarLight chrome		

# FAIRFIELD INN - GENERATION 4.5

Marriott Global Design Standard  
May 2023



## ADA SHOWER ONLY (ADA SHOWER LAYOUT 3)

 	<b>SKU No.</b> 215AA104.020	<b>P-Number</b> NOT ON SPEC PL-301-LI_WCL-05	<b>Color/Finish</b> White	
	<b>List</b>	<b>Net</b>	<b>Quantity</b> 1	<b>Total</b>
	<b>American Standard Cadet® Pro™ Right Height® Elongated Toilet</b> Collection CADET® PRO™ Fixture Type Toilet Toilet Type Tank type Mounting And Waste Floor mounted with floor outlet Toilet Water Consumption High Efficiency HET 4.8 LPF (1.28 GPF) Material Vitreous china Antimicrobial EverClean® antimicrobial surface Color / Finish White Bowl Shape Elongated bowl			
 	<b>SKU No.</b> 211AA104.020	<b>P-Number</b> NOT ON SPEC PL-301-LI_WCL-05	<b>Color/Finish</b> White	
	<b>List</b>	<b>Net</b>	<b>Quantity</b> 1	<b>Total</b>
	<b>American Standard Champion® Pro Right Height® Elongated Toilet</b> Collection CHAMPION® PRO™ Fixture Type Toilet Toilet Type Tank type Mounting And Waste Floor mounted with floor outlet Toilet Water Consumption High Efficiency HET 4.8 LPF (1.28 GPF) Material Vitreous china Antimicrobial EverClean® antimicrobial surface Color / Finish White Bowl Shape Elongated bowl			

# FAIRFIELD INN - GENERATION 4.5

Marriott Global Design Standard

May 2023



## ADA SHOWER ONLY (ADA SHOWER LAYOUT 3)







	<b>SKU No.</b>	<b>P-Number</b>	<b>Color/Finish</b>
	5503A00B.020	PL-302-LI_WCL-04	White
	<b>List</b>	<b>Net</b>	<b>Quantity</b>
		1	
	<b>American Standard Toilet Seat For Round Bowl With Seat Cover</b>		
	Toilet Bowl	For elongated bowl	
	Application	For residential applications	
	Grade	Standard	
	Cover	With seat cover	
	Color / Finish	White	

# FAIRFIELD INN - GENERATION 4.5

Marriott Global Design Standard  
May 2023



## ADA TUB/SHOWER COMBO (LAYOUT 4)

    	<b>SKU No.</b> 2312900A	<b>P-Number</b> NOT ON SPEC PL-202-LI_SNK-04	<b>Color/Finish</b> StarLight chrome	
	<b>List</b>	<b>Net</b>	<b>Quantity</b> 1	<b>Total</b>
	<b>GROHE Single-Handle Bathroom Faucet S-Size</b>			
	Collection	EUROCUBE		
	Flow Rate	4.5 LPM (1.2 GPM) maximum flowrate		
	Faucet Flow Control	GROHE EcoJoy Mousseur		
	Operation	Manual		
	Number of Handles	Single handle		
	Faucet Type	Lavatory faucet		
	Color / Finish	StarLight chrome		
	EPA WaterSense	EPA WaterSense® compliant		
 	<b>SKU No.</b> 0614000.020	<b>P-Number</b> PL-103-LI_SNK-05	<b>Color/Finish</b> White finish	
	<b>List</b>	<b>Net</b>	<b>Quantity</b> 1	<b>Total</b>
	<b>American Standard Studio Undercounter Sink</b>			
	Collection	STUDIO		
	Basin Type	Lavatory		
	Material	Vitreous china		
	Color / Finish	White finish		
	Mounting	Counter mounted		
	ADA	ANSI A117.1 compliant		

# FAIRFIELD INN - GENERATION 4.5

Marriott Global Design Standard  
May 2023



## ADA TUB/SHOWER COMBO (LAYOUT 4)

	<b>SKU No.</b>	<b>P-Number</b>	<b>Color/Finish</b>
	26043001	NOT ON SPEC PL-401-A1-LI_TUB-02	StarLight chrome
	<b>List</b>	<b>Net</b>	<b>Quantity</b>
			1
	<b>GROHE New Tempesta Cosmopolitan 100 Shower Head 4 Sprays</b>		
	ASME Compliance	ASME A112.18.1	
	CALGreen Compliance	CALGreen compliant	
	CEC	California Energy Commission (CEC) compliant	
	Cleaning	SpeedClean® anti-lime system	
	Connection	1/2" connection thread	
	CSA Compliance	CSA B125.1	
	EPA Compliance	Energy Policy Act of 1992	
	EPA Watersense	EPA WaterSense®	
	Face Diameter	4" face	
	Color / Finish	StarLight chrome	
	Flow Rate	EcoJoy 2.0 GPM (7.6 l/min) flow limiter	
	Function	4 sprays: GROHE Rain O <sup>2</sup> , Rain, Massage and Jet	
	Installation	Installed on shower arm	
	Manufacturer	GROHE	
	Minimum Pressure	103 kPa (15 PSI) minimum recommended pressure	
	Shower Head Type	Residential	
	Spray	Multispray	
	Spray Pattern	DreamSpray perfect spray pattern	
	US Federal	US Federal and State material regulations compliant	





# FAIRFIELD INN - GENERATION 4.5

Marriott Global Design Standard  
May 2023



## ADA TUB/SHOWER COMBO (LAYOUT 4)



	<b>SKU No.</b> 9038074.002	<b>P-Number</b> NOT ON SPEC PL-401-A2-LI_TUB-02	<b>Color/Finish</b> Polished chrome	
	<b>List</b>	<b>Net</b>	<b>Quantity</b> 1	<b>Total</b>
	<b>American Standard Spectra+™ 4-Function Showerhead</b> Compliances and Certifications ASME A112.18.1, CSA B125.1 Color / Finish Polished chrome Flow Control Device Provides consistent flow over a wide pressure range Flow Rate 1.8 GPM (6.8 LPM) showerhead flowrate Function 4-Function (Drench to Sensitive to Jet to Massage) Installation Installed on shower arm Manufacturer American Standard Model Type Showerhead Shower Head Type Residential Spray Allows the user to select the type of spray best suited to their needs EPA WaterSense EPA WaterSense® compliant			
 	<b>SKU No.</b> 29426000	<b>P-Number</b> NOT ON SPEC PL-801-LI_TUB-02	<b>Color/Finish</b> StarLight chrome	
	<b>List</b>	<b>Net</b>	<b>Quantity</b> 1	<b>Total</b>
	<b>GROHE Eurocube® Pressure Balance Valve Trim With 3-Way Diverter With Cartridge</b> Kit Type Valve trim Color / Finish StarLight chrome ADA ADA compliant			

# FAIRFIELD INN - GENERATION 4.5

Marriott Global Design Standard  
May 2023



## ADA TUB/SHOWER COMBO (LAYOUT 4)

	<b>SKU No.</b>	<b>P-Number</b>	<b>Color/Finish</b>
	35117000	NOT ON SPEC PL-801-LI_TUB-02	
	<b>List</b>	<b>Net</b>	<b>Quantity</b> 1
<b>GROHE Grohsafe™ Pressure Balance Rough-In Valve With Integrated Diverter</b>			
Model Type		Pressure Balance valve	
	<b>SKU No.</b>	<b>P-Number</b>	<b>Color/Finish</b>
	13305000	NOT ON SPEC PL-801-LI_TUB-02	StarLight chrome
	<b>List</b>	<b>Net</b>	<b>Quantity</b> 1
<b>GROHE Tub Spout</b>			
Collection		EUROCUBE	
Compliances and Certifications		Energy Policy Act of 1992, ASME A112.18.1/CSA B125.1, EPACT92 compliant, ICC/ANSI A117.1 compliant	
Discharge Type		Flow control	
Diverter		Non diverter tub spout	
Color / Finish		Chrome	
Manufacturer		GROHE	
Mounting		Wall-hung	
Projection		170 mm (6-11/16")	
Thread		1/2" NPT female thread	
Thread Size		1/2	
Type		Tub spout	

# FAIRFIELD INN - GENERATION 4.5

Marriott Global Design Standard  
May 2023



## ADA TUB/SHOWER COMBO (LAYOUT 4)



	<b>SKU No.</b> 26633000	<b>P-Number</b> NOT ON SPEC PL-801-LI_TUB-02	<b>Color/Finish</b> StarLight chrome	
	<b>List</b>	<b>Net</b>	<b>Quantity</b> 1	<b>Total</b>
	<b>GROHE Relaxa Shower Wall Union, 1/2"</b>			
	CEC	CEC		
	Compliances and Certifications	ASME A112.18.1/CSA B125.1		
	Connection	1/2" NPT connection thread(s)		
	CSA Compliance	CSA B125.1		
	Escutcheon	With square escutcheon		
	Color / Finish	StarLight chrome		
	Manufacturer	GROHE		
	Material	Metal		
	Shower Arm	152 mm (6") shower arm		
	UPC	cUPC compliant		
 	<b>SKU No.</b> 27575002	<b>P-Number</b> NOT ON SPEC PL-404-LI_TUB-02	<b>Color/Finish</b> StarLight chrome	
	<b>List</b>	<b>Net</b>	<b>Quantity</b> 1	<b>Total</b>
	<b>GROHE New Tempesta Cosmopolitan 100</b>			
	Flow Rate	2.5 GPM (9.5 l/min) flow limiter		
	Color / Finish	StarLight chrome		

# FAIRFIELD INN - GENERATION 4.5

Marriott Global Design Standard  
May 2023



## ADA TUB/SHOWER COMBO (LAYOUT 4)



	<b>SKU No.</b> 95866000	<b>P-Number</b> NOT ON SPEC PL-404-LI_TUB-02	<b>Color/Finish</b> Starlight chrome	
	<b>List</b>	<b>Net</b>	<b>Quantity</b> 1	<b>Total</b>
	<b>GROHE Volume Control For Shower Heads &amp; Hand Showers</b> ANSI Compliance      ICC/ANSI A117.1 Color / Finish          Starlight chrome Flow Rate                 Adjusts from 2.5 GPM to a trickle flow Non-Positive Shutoff    Non-Positive shutoff			
	<b>SKU No.</b> 07911000	<b>P-Number</b> NOT ON SPEC PL-404-LI_TUB-02	<b>Color/Finish</b> Starlight chrome	
	<b>List</b>	<b>Net</b>	<b>Quantity</b> 1	<b>Total</b>
	<b>GROHE 1/2" Inline Vacuum Breaker</b> Application                Inline Color / Finish              Starlight chrome Fixture Type                Vacuum breaker Manufacturer               GROHE Size                            13 mm (1/2")			

# FAIRFIELD INN - GENERATION 4.5

Marriott Global Design Standard  
May 2023



## ADA TUB/SHOWER COMBO (LAYOUT 4)



	<b>SKU No.</b> 28143000	<b>P-Number</b> NOT ON SPEC PL-404-LI_TUB-02	<b>Color/Finish</b> Starlight chrome	
	<b>List</b>	<b>Net</b>	<b>Quantity</b> 1	<b>Total</b>
	<b>GROHE Relexaflex Metal Longlife Metal Shower Hose 1500</b> Connection Universal connection G 1/2" x 1/2" Color / Finish Starlight chrome Heat Resistance 165 °F Length 1499 mm (59") long Material Metal Pressure Resistance Pressure resistance up to 16 bar Tensile Strength Tensile strength 500 N			
	<b>SKU No.</b> 26634000	<b>P-Number</b> NOT ON SPEC PL-404-LI_TUB-02	<b>Color/Finish</b> StarLight chrome	
	<b>List</b>	<b>Net</b>	<b>Quantity</b> 1	<b>Total</b>
	<b>GROHE Euphoria Cube Shower Wall Union, 1/2"</b> ASME A112.18 ASME A112.18.1 compliant CALGreen Compliance CALGreen® compliant CEC LOGO CEC compliant Check Valve Check valve included to prevent backflow Connection Type 1/2" NPT female thread CSA B125 CSA B125.1 compliant Energy Policy Act of 1992 Energy Policy Act of 1992 Color / Finish StarLight chrome Manufacturer GROHE UPC UPC compliant			

# FAIRFIELD INN - GENERATION 4.5

Marriott Global Design Standard  
May 2023



## ADA TUB/SHOWER COMBO (LAYOUT 4)





	<b>SKU No.</b> 27693000	<b>P-Number</b> NOT ON SPEC PL-404-LI_TUB-02	<b>Color/Finish</b> StarLight chrome	
	<b>List</b>	<b>Net</b>	<b>Quantity</b> 1	<b>Total</b>
	<b>GROHE Euphoria Cube Wall Hand Shower Holder</b> Adjustable Non-Adjustable shower head Color / Finish StarLight chrome Manufacturer GROHE			
  	<b>SKU No.</b> 1660.730.002	<b>P-Number</b> NOT ON SPEC PL-404-LI_TUB-02	<b>Color/Finish</b> Polished chrome	
	<b>List</b>	<b>Net</b>	<b>Quantity</b> 1	<b>Total</b>
	<b>American Standard 30 Inch Round Shower Slide Bar</b> Color / Finish Polished chrome Fixture Type SLIDE BAR Length 805 mm (31-11/16") long Manufacturer American Standard Model Adjustable shower holder can be set at any height or position along the bar and angles up to 45 degrees Model Type STANDARD Width 124 mm (4-7/8") wide			

# FAIRFIELD INN - GENERATION 4.5

Marriott Global Design Standard  
May 2023



## ADA TUB/SHOWER COMBO (LAYOUT 4)



 	<b>SKU No.</b> 2390.202.020	<b>P-Number</b> PL-601-LI-TUB-02	<b>Color/Finish</b> White	
	<b>List</b>	<b>Net</b>	<b>Quantity</b> 1	<b>Total</b>
	<b>American Standard Princeton® Recess Bath (Below Floor Installation)</b> Installation Alcove Bath Type Bathing pool Material Americast® brand engineered material, Acid resistant porcelain finish Color / Finish White Installed Size 60 x 30 x 17-1/2" (1524 x 762 x 445 mm) Dimensions 1524 x 762 x 356 mm (60" x 30" x 14")			
 	<b>SKU No.</b> 2391.202.020	<b>P-Number</b> PL-601-LI-TUB-02	<b>Color/Finish</b> White	
	<b>List</b>	<b>Net</b>	<b>Quantity</b> 1	<b>Total</b>
	<b>American Standard Princeton® Recess Bath (Below Floor Installation)</b> Installation Alcove Bath Type Bathing pool Material Americast® brand engineered material, Acid resistant porcelain finish Color / Finish White Installed Size 60 x 30 x 17-1/2" (1524 x 762 x 445 mm) Dimensions 1524 x 762 x 356 mm (60" x 30" x 14")			

# FAIRFIELD INN - GENERATION 4.5

Marriott Global Design Standard  
May 2023



## ADA TUB/SHOWER COMBO (LAYOUT 4)

	<b>SKU No.</b> 1640.305.002	<b>P-Number</b> PL-901-LI_TUB-02	<b>Color/Finish</b> Polished chrome	
	<b>List</b>	<b>Net</b>	<b>Quantity</b> 1	<b>Total</b>
	<b>American Standard Deep Soak® Bathtub Drain</b> Fixture Type                      Bathtub drain Color / Finish                      Polished chrome			
 	<b>SKU No.</b> 215AA104.020	<b>P-Number</b> NOT ON SPEC PL-301-LI_WCL-05	<b>Color/Finish</b> White	
	<b>List</b>	<b>Net</b>	<b>Quantity</b> 1	<b>Total</b>
	<b>American Standard Cadet® Pro™ Right Height® Elongated Toilet</b> Collection                              CADET® PRO™ Fixture Type                              Toilet Toilet Type                                  Tank type Mounting And Waste                      Floor mounted with floor outlet Toilet Water Consumption                      High Efficiency HET 4.8 LPF (1.28 GPF) Material    Vitreous china Antimicrobial                                  EverClean® antimicrobial surface Color / Finish                                  White Bowl Shape                                      Elongated bowl			

# FAIRFIELD INN - GENERATION 4.5

Marriott Global Design Standard  
May 2023



## ADA TUB/SHOWER COMBO (LAYOUT 4)





 	<b>SKU No.</b> 211AA104.020	<b>P-Number</b> NOT ON SPEC PL-301-LI_WCL-05	<b>Color/Finish</b> White	
	<b>List</b>	<b>Net</b>	<b>Quantity</b> 1	<b>Total</b>
	<b>American Standard Champion® Pro Right Height® Elongated Toilet</b> Collection CHAMPION® PRO™ Fixture Type Toilet Toilet Type Tank type Mounting And Waste Floor mounted with floor outlet Toilet Water Consumption High Efficiency HET 4.8 LPF (1.28 GPF) Material Vitreous china Antimicrobial EverClean® antimicrobial surface Color / Finish White Bowl Shape Elongated bowl			
	<b>SKU No.</b> 5503A00B.020	<b>P-Number</b> NOT ON SPEC PL-302-LI_WCL-04	<b>Color/Finish</b> White	
	<b>List</b>	<b>Net</b>	<b>Quantity</b> 1	<b>Total</b>
	<b>American Standard Toilet Seat For Round Bowl With Seat Cover</b> Toilet Bowl For elongated bowl Application For residential applications Grade Standard Cover With seat cover Color / Finish White			

# FAIRFIELD INN - GENERATION 4.5

Marriott Global Design Standard  
May 2023



## KITCHEN/BAR AREA







  	<b>SKU No.</b> 3287700A	<b>P-Number</b> NOT ON SPEC PL-202-LI_SNK-03	<b>Color/Finish</b> StarLight chrome	
	<b>List</b>	<b>Net</b>	<b>Quantity</b> 1	<b>Total</b>
	<b>GROHE Eurosmart Cosmopolitan Single-Handle Bathroom Faucet S-Size</b> Collection                   EUROSMART COSMOPOLITAN Flow Rate                       4.5 LPM (1.2 GPM) maximum flowrate Faucet Flow Control       Adjustable flowrate limiter Operation                       Manual Number of Handles         Single handle Faucet Type                   Lavatory faucet Color / Finish                StarLight chrome ADA                               ANSI A117.1 compliant EPA WaterSense             EPA WaterSense® compliant			
 	<b>SKU No.</b> 22SB.6252283S.075	<b>P-Number</b> NOT ON SPEC PL-101-LI_SNK-02/ PL-101-LI_SNK-02	<b>Color/Finish</b> Stainless steel	
	<b>List</b>	<b>Net</b>	<b>Quantity</b> 1	<b>Total</b>
	<b>American Standard 25 X 22 ADA Single Bowl Stainless Steel Kitchen Sink 20 Gauge Stainless Steel Barrier Free</b> Compartment               Single compartment Material                       Stainless steel Mounting                       Counter mounted Counter Installation       Drop-in Sink Type                       Kitchen sink Centerset                       203 mm (8") centerset			

# FAIRFIELD INN - GENERATION 4.5

Marriott Global Design Standard  
May 2023



## BACK OF HOUSE

    	<b>SKU No.</b> 2312900A	<b>P-Number</b> NOT ON SPEC PL-202-LI_SNK-04	<b>Color/Finish</b> StarLight chrome	
	<b>List</b>	<b>Net</b>	<b>Quantity</b> 1	<b>Total</b>
	<b>GROHE Single-Handle Bathroom Faucet S-Size</b>			
	Collection Flow Rate Faucet Flow Control Operation Number of Handles Faucet Type Color / Finish EPA WaterSense	EUROCUBE 4.5 LPM (1.2 GPM) maximum flowrate GROHE EcoJoy Mousseur Manual Single handle Lavatory faucet StarLight chrome EPA WaterSense® compliant		
 	<b>SKU No.</b> 0614000.020	<b>P-Number</b> NOT ON SPEC PL-103-LI_SNK-03/ PL-103-LI_SNK-04	<b>Color/Finish</b> White finish	
	<b>List</b>	<b>Net</b>	<b>Quantity</b> 1	<b>Total</b>
	<b>American Standard Studio Undercounter Sink</b>			
	Collection Basin Type Material Color / Finish Mounting ADA	STUDIO Lavatory Vitreous china White finish Counter mounted ANSI A117.1 compliant		

# FAIRFIELD INN - GENERATION 4.5

Marriott Global Design Standard  
May 2023



## BACK OF HOUSE









 	<b>SKU No.</b> 22SB.6252283S.075	<b>P-Number</b> NOT ON SPEC PL-101-LI_SNK-02/ PL-101-LI_SNK-02	<b>Color/Finish</b> Stainless steel	
	<b>List</b>	<b>Net</b>	<b>Quantity</b> 1	<b>Total</b>
	<b>American Standard 25 X 22 ADA Single Bowl Stainless Steel Kitchen Sink 20 Gauge Stainless Steel Barrier Free</b> Compartment                      Single compartment Material                              Stainless steel Mounting                              Counter mounted Counter Installation              Drop-in Sink Type                              Kitchen sink Centerset                              203 mm (8") centerset			
    	<b>SKU No.</b> 7074000.002	<b>P-Number</b> PL-201-A1-LI_SNK-02	<b>Color/Finish</b> Polished chrome	
	<b>List</b>	<b>Net</b>	<b>Quantity</b> 1	<b>Total</b>
	<b>American Standard Colony Pro Single Control Kitchen Faucet</b> Collection                            COLONY PRO Flow Rate                              5.7 LPM (1.5 GPM) maximum flowrate Faucet Flow Control              Pressure compensating aerator Operation                              Manual Number of Handles                Single handle Faucet Type                          Sink faucet Color / Finish                        Polished chrome ADA                                        ANSI A117.1 compliant			

# FAIRFIELD INN - GENERATION 4.5

Marriott Global Design Standard  
May 2023



## BACK OF HOUSE

    	<b>SKU No.</b> 7074040.002	<b>P-Number</b> PL-201-A2-LI_SNK-02	<b>Color/Finish</b> Polished chrome	
	<b>List</b>	<b>Net</b>	<b>Quantity</b> 1	<b>Total</b>
	<b>American Standard Colony Pro Single Control Kitchen Faucet</b> Collection COLONY PRO Flow Rate 5.7 LPM (1.5 GPM) maximum flowrate Faucet Flow Control Pressure compensating aerator Operation Manual Number of Handles Single handle Faucet Type Sink faucet Color / Finish Polished chrome ADA ANSI A117.1 compliant			
  	<b>SKU No.</b> 7074240.002	<b>P-Number</b> PL-204-LI_SVS-01	<b>Color/Finish</b> Polished chrome	
	<b>List</b>	<b>Net</b>	<b>Quantity</b> 1	<b>Total</b>
	<b>American Standard Colony Pro Two-Handle Laundry Faucet With Brass Swing Spout</b> Collection COLONY® Flow Rate No flow restrictor Faucet Flow Control Threaded hose end Operation Manual Number of Handles Two handles Faucet Type Laundry faucet Color / Finish Polished chrome ADA ANSI A117.1 compliant			

# FAIRFIELD INN - GENERATION 4.5

Marriott Global Design Standard  
May 2023



## BACK OF HOUSE

  	<b>SKU No.</b> 8344212.004	<b>P-Number</b> PL-205-LI_MOP-01	<b>Color/Finish</b> Rough chrome	
	<b>List</b>	<b>Net</b>	<b>Quantity</b> 1	<b>Total</b>
	<b>American Standard Exposed Yoke Wall-Mount Utility Faucet With Top Brace</b> Flow Rate 56.7 LPM (15 GPM) maximum flowrate Faucet Flow Control Threaded hose end Operation Manual Number of Handles Two handles Faucet Type Mop sink faucet Color / Finish Rough chrome			
   	<b>SKU No.</b> 3043001.020	<b>P-Number</b> PL-303-LI_WCL-01	<b>Color/Finish</b> White	
	<b>List</b>	<b>Net</b>	<b>Quantity</b> 1	<b>Total</b>
	<b>American Standard Madera™ Flowise® 16-1/2" Height Elongated Flushometer Toilet</b> Collection MADERA™ FloWise® Fixture Type Toilet Toilet Type For flush valve Mounting And Waste Floor mounted with floor outlet Toilet Water Consumption Toilet operates in the range of 4.2 to 6.0 LPF (1.1 - 1.6 GPF) Material Vitreous china Color / Finish White Bowl Shape Elongated bowl			

# FAIRFIELD INN - GENERATION 4.5

Marriott Global Design Standard  
May 2023



## BACK OF HOUSE







    	<b>SKU No.</b> 3461001.020	<b>P-Number</b> PL-310-LI_WCL-02/ PL-308-LI_WCL-03	<b>Color/Finish</b> White	
	<b>List</b>	<b>Net</b>	<b>Quantity</b> 1	<b>Total</b>
	<b>American Standard Madera™ Flowise® 16-1/2" Height Elongated Flushometer Toilet</b> Collection MADERA™ FloWise® Fixture Type Toilet Toilet Type For flush valve Mounting And Waste Floor mounted with floor outlet Toilet Water Consumption Toilet operates in the range of 4.2 to 6.0 LPF (1.1 - 1.6 GPF) Material Vitreous china Antimicrobial EverClean® antimicrobial surface Color / Finish White Bowl Shape Elongated bowl			
	<b>SKU No.</b> 5901100.020	<b>P-Number</b> PL-304-LI_WCL-01/ PL-304-LI_WCL-02/ PL-304-LI_WCL-03	<b>Color/Finish</b> White	
	<b>List</b>	<b>Net</b>	<b>Quantity</b> 1	<b>Total</b>
	<b>American Standard Commercial Heavy Duty Toilet Seat For Elongated Bowl Open Front Less Seat Cover Everclean Antimicrobial Surface</b> Toilet Bowl For elongated bowl Application For commercial applications Grade Heavy duty Seat Type Open front Cover Less seat cover Color / Finish White			

# FAIRFIELD INN - GENERATION 4.5

Marriott Global Design Standard  
May 2023



## BACK OF HOUSE

	<b>SKU No.</b> 6247121.002	<b>P-Number</b> PL-307-LI_WCL-01/ PL-307-LI_WCL-02/ PL-307-LI_WCL-03	<b>Color/Finish</b> Polished chrome	
	<b>List</b>	<b>Net</b>	<b>Quantity</b> 1	<b>Total</b>
	<b>American Standard Ultima® Selectronic® Exposed Toilet Flush Valve Diaphragm-Type</b> Collection                      ULTIMA SELECTRONIC® Flush Valve Type                Toilet flush valve Installation                        Exposed Flush Valve Operation          Automatic no-touch Power Type                         Battery powered Color / Finish                     Polished chrome Flush Valve Water Consumption    High Efficiency 4.8 LPF (1.28 GPF)			
 				
	<b>SKU No.</b> 6247161.002	<b>P-Number</b> PL-308-LI_WCL-01/ PL-308-LI_WCL-02/ PL-306-LI_WCL-03	<b>Color/Finish</b> Polished chrome	
	<b>List</b>	<b>Net</b>	<b>Quantity</b> 1	<b>Total</b>
	<b>American Standard Ultima® Selectronic® Exposed Toilet Flush Valve Diaphragm-Type</b> Collection                      ULTIMA SELECTRONIC® Flush Valve Type                Toilet flush valve Installation                        Exposed Flush Valve Operation          Automatic no-touch Power Type                         Battery powered Color / Finish                     Polished chrome Flush Valve Water Consumption    Low consumption 6.0 LPF (1.6 GPF)			
 				

# Related Literature



Residential Fixtures and Faucets List Price Guide 2022



2021 LIXIL Builder Advantage Program Brochure



Ultima® Diaphragm Flush Valves Sell Sheet

## Find Our Products Here

### REVIT, Specs, CAD and BIM Availability

Through our partner ATS, American Standard Brands provides a complete plumbing specification solution for your Revit and 3D projects. With over 8,500 product combinations accessible for immediate download and new files being added daily, ATS is the largest source for Revit plumbing equipment. ATS and American Standard’s combined 3D BIM families can be easily accessed and downloaded at no-cost to the specification design community. For more information, please visit our partner website, [www.atsspec.net](http://www.atsspec.net).

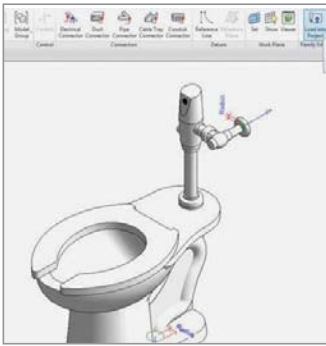

Revit Families Available

Our products are specified in  
**SpecLink**  
[www.bsdspeclink.com](http://www.bsdspeclink.com)



### For American Standard Customer Care

Call 1-800-442-1902 – Monday – Friday, 8:00 am – 7:00 pm EST

Visit [www.americanstandard.com](http://www.americanstandard.com)

**Front Cover:** Cadet® Touchless Chair Height Elongated Toilet Less Seat - 215AA709.002